

NSK

SUPER LONG-LIFE SPHERICAL ROLLER BEARINGS

FOR VIBRATING MACHINERY AND EQUIPMENT



STAY IN MOTION. STAY IN CONTROL.



UNRELENTING GRIT

BEARINGS FOR MINING, QUARRYING & CONSTRUCTION

Punishing Loads. Misalignment. Mechanical shock. Grit and contamination and marginal lubrication. A day in a life for bearings used in mining, quarrying and construction industries.

For the machinery and equipment used to extract, transport and process - interdependent in their purpose - access can be remote or restricted. The unexpected failure of a single component can bring an entire site to a standstill - at a significant cost.

For NSK, product development and design is focused squarely on withstanding the manifold operating and environmental stresses of these applications with:

- › increasing capacities for high loads and high speeds
- › advanced materials for durability, wear resistance and longer life
- › lubrication and seal technology for smooth and clean running

Our product solutions are designed to optimize the performance of machinery and equipment, to assure predictable reliability and to deliver total cost-efficiency.

UNSHAKABLE: VE SERIES SPHERICAL ROLLER BEARINGS

NSK's long-life VE series spherical roller bearings are engineered specifically for vibrating screens and feeders - where a host of operating challenges come together in a relentless perfect storm. An optimized internal bearing design and tightly controlled clearance and dimensional tolerances deliver robust performance over a long operating life.

PROVEN ADVANTAGES

- › As much as twice the service life of conventional bearings in applications subject to frequent vibration
- › High resistance to heavy and shock loads
- › Surface finish minimizes sliding contact in high load zones and facilitates better lubricant film
- › Superior roller guidance and lubricant distribution from machined brass cage
 - › High-speed performance with low temperature rise
 - › Reduced bearing damage from slippage, surface fatigue and flaking
 - › Higher operational reliability - reduced maintenance costs



DESIGN FEATURES AND OPERATING ADVANTAGES

NSK's VE series spherical roller bearings are designed specifically - and ideally - to contend with high speeds, shock loads, misalignment and frequent vibration, and deliver robust, smooth running, long-life performance.



DESIGN FEATURES

- › Manufactured from ultra-clean steel for optimal fatigue strength and longer life
- › Heavy-duty, precision machined one-piece brass cage
- › Advanced raceway surface finishing for durability and wear resistance
- › Special dimensional tolerances - set at 1/2 relative to the normal - to minimize vibration during operation
- › Special internal clearance - set at upper 2/3 relative to the standard - for optimal operating clearance and reduced heat generation
- › Available in spherical roller bearing series 223 and 233 for bore diameters 40 to 220 mm
- › Available with Hi-TF and Super-TF material options

HIGH PERFORMANCE MACHINED BRASS CAGE

For applications with inherently high loads, shock loads and frequent vibration, a robust cage is essential to sustainable bearing performance. The punishment dealt in vibrating machinery applications in particular often presents far too great a challenge for pressed steel cages, resulting in problems ranging from bearing damage caused by excessive cage wear to catastrophic bearing failure due to outright cage fracture.

For these reasons, NSK VE series spherical roller bearings are designed exclusively with a heavy-duty, wear resistant machined brass cage that offers considerable advantages above and beyond its durability:

- › Cage pocket geometry and finger length provide superior roller guidance and controlled roller skew
- › Precision-machined contours optimize lubricant flow to rolling contact surfaces
- › Inner ring guided design delivers robust performance and superior stability, even in heavy shock loads



HIGH PERFORMANCE MATERIAL OPTION

For severely contaminated service conditions, NSK offers our Hi-TF and Super-TF long-life material options. Through advanced material and heat treatment technology, NSK's Tough Steel provides considerable advantages over conventional materials:

- › Exponentially longer life in contaminated lubrication conditions, and twice the fatigue life in normal conditions
- › As low as one-third the normal rate of wear
- › Up to 40% improvement to seizure resistance

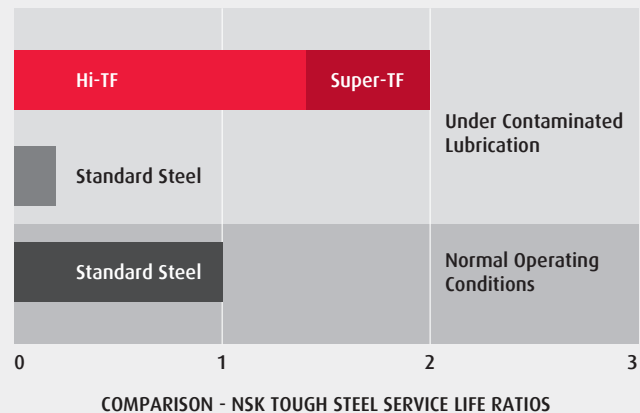

BEARING DIMENSIONS AND OPERATING VALUES

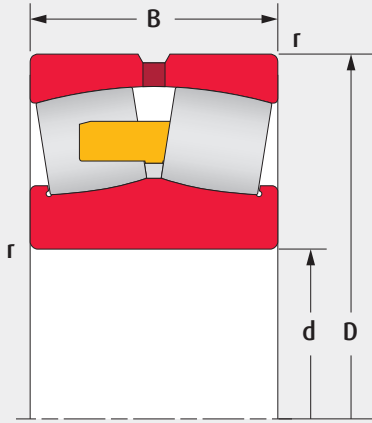

Series 223

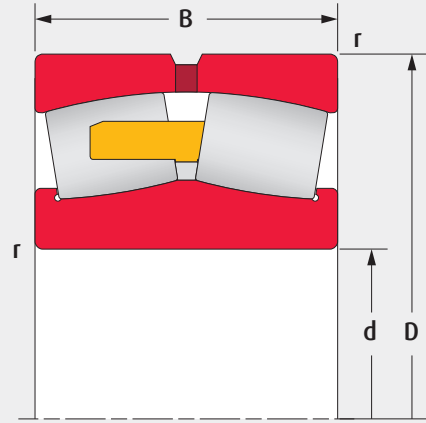

Series 233

BASIC BEARING NO.	BEARING DIMENSIONS				BASIC LOAD RATINGS				LIMITING SPEEDS	
	mm				N		lbf		rpm	
	d	D	B	r (min)	Dynamic	Static	Dynamic	Static	Grease	Oil
22308	40	90	33	1.5	152 000	129 000	34 000	29 000	4 300	5 300
22309	45	100	36	1.5	185 000	167 000	42 000	38 000	3 800	4 800
22310	50	110	40	2.0	232 000	211 000	52 000	47 000	3 600	4 300
22311	55	120	43	2.0	261 000	241 000	59 000	54 000	3 200	4 000
22312	60	130	46	2.1	305 000	288 000	69 000	65 000	3 000	3 600
22313	65	140	48	2.1	330 000	315 000	74 000	71 000	2 800	3 400
22314	70	150	51	2.1	380 000	470 000	85 000	106 000	2 600	3 200
22315	75	160	55	2.1	425 000	415 000	96 000	93 000	2 400	3 000
22316	80	170	58	2.1	485 000	480 000	109 000	108 000	2 200	2 800
22317	85	180	60	3.0	520 000	510 000	117 000	115 000	2 000	2 600
22318	90	190	64	3.0	605 000	595 000	136 000	134 000	2 000	2 400
22319	95	200	67	3.0	655 000	675 000	147 000	152 000	1 900	2 400
22320	100	215	73	3.0	750 000	785 000	169 000	176 000	1 700	2 200
22322	110	240	80	3.0	925 000	980 000	208 000	220 000	1 600	1 900
22324	120	260	86	3.0	1 060 000	1 120 000	238 000	252 000	1 400	1 800
22326	130	280	93	4.0	1 240 000	1 350 000	279 000	304 000	1 300	1 600
22328	140	300	102	4.0	1 450 000	1 590 000	326 000	357 000	1 200	1 500
22330	150	320	108	4.0	1 530 000	1 690 000	344 000	380 000	1 100	1 400
22332	160	340	114	4.0	1 700 000	1 900 000	382 000	427 000	1 100	1 300
22334	170	360	120	4.0	1 970 000	2 110 000	443 000	474 000	1 000	1 200
22336	180	380	126	4.0	2 170 000	2 340 000	488 000	526 000	950	1 200
22338	190	400	132	5.0	2 370 000	2 590 000	533 000	582 000	900	1 100

Dimensional tolerance for the bearings is set at 1/2 relative to the normal tolerances for outer and inner diameters.

The radial internal clearance is set at upper 2/3 relative to the standard.

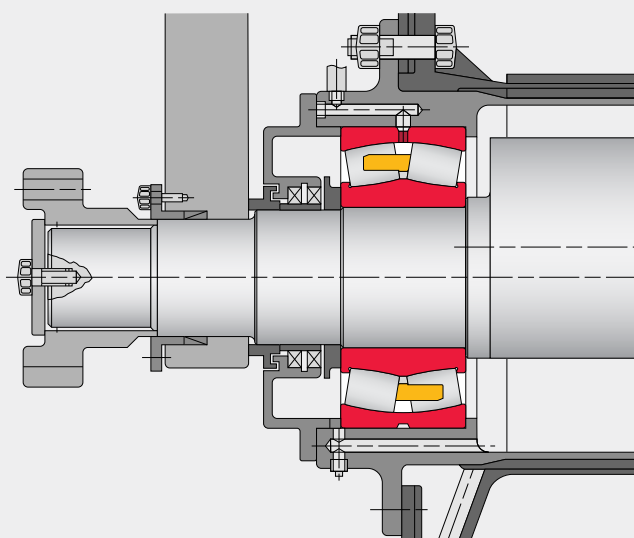

BASIC BEARING NO.	BEARING DIMENSIONS				BASIC LOAD RATINGS				LIMITING SPEEDS	
	mm				N		lbf		rpm	
	d	D	B	r (min)	Dynamic	Static	Dynamic	Static	Grease	Oil
23322	110	240	92	3.0	778 000	1 050 000	175 000	236 000	1 700	2 200
23324	120	260	106	3.0	961 000	1 310 000	216 000	295 000	1 500	1 900
23326	130	280	112	4.0	1 040 000	1 430 000	234 000	321 000	1 400	1 800
23328	140	300	118	4.0	1 240 000	1 780 000	279 000	400 000	1 300	1 700
23330	150	320	128	4.0	1 400 000	2 000 000	315 000	450 000	1 200	1 500
23332	160	340	136	4.0	1 550 000	2 270 000	349 000	510 000	1 100	1 400
23338	190	400	155	5.0	2 080 000	3 100 000	468 000	697 000	950	1 200
23340	200	420	165	5.0	2 340 000	3 550 000	526 000	798 000	900	1 100
23344	220	460	180	6.0	2 800 000	4 300 000	629 000	967 000	800	1 000

RECOMMENDED SHAFT AND HOUSING FITS

Ensuring appropriate interference between mating surfaces is imperative to optimize the operating life of spherical roller bearings in vibrating equipment.

It is recommended to inspect fits prior to installation: measure and record shaft and housing dimensions and review the values with the recommendations in the tables below.

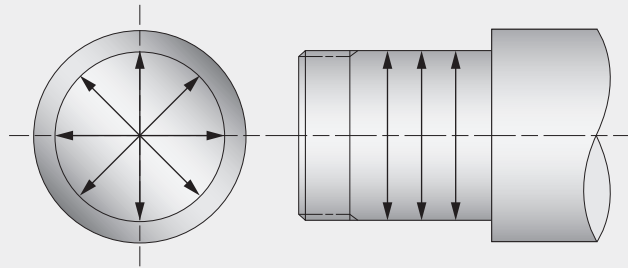

Checking Cylindrical Shafts

BASIC BEARING NO.		BEARING BORE DIAMETER DIMENSIONS					RECOMMENDED SHAFT FIT		
		mm	Tolerance μm		inch		inch		Resulting Fit
223	233	shaft	max	min	max	min	max	min	
22308	—	40	0	-7	1.5748	1.5745	1.5744	1.5738	10 L / 1 L
22309	—	45			1.7717	1.7714	1.7713	1.7707	
22310	—	50			1.9685	1.9682	1.9681	1.9675	
22311	—	55	0	-9	2.1653	2.1650	2.1650	2.1642	11 L / 0 L
22312	—	60			2.3622	2.3618	2.3618	2.3611	
22313	—	65			2.5590	2.5587	2.5587	2.5579	
22314	—	70			2.7559	2.7555	2.7555	2.7548	
22315	—	75			2.9527	2.9524	2.9524	2.9516	
22316	—	80			3.1496	3.1492	3.1492	3.1485	
22317	—	85	0	-12	3.3464	3.3460	3.3460	3.3451	13 L / 0 L
22318	—	90			3.5433	3.5428	3.5428	3.5420	
22319	—	95			3.7401	3.7397	3.7397	3.7388	
22320	—	100			3.9370	3.9365	3.9365	3.9357	
22322	23322	110			4.3307	4.3302	4.3302	4.3294	
22324	23324	120	4.7244	4.7239	4.7239	4.7231	27 L / 11 L		
22326	23326	130	5.1181	5.1175	5.1164	5.1154			
22328	23328	140	5.5118	5.5112	5.5101	5.5091			
22330	23330	150	5.9055	5.9049	5.9038	5.9028			
22332	23332	160	6.2992	6.2986	6.2975	6.2965			
22334	—	170	6.6929	6.6923	6.6912	6.6902			
22336	—	180	7.0866	7.0860	7.0849	7.0839	31 L / 13 L		
22338	23338	190	7.4803	7.4796	7.4783	7.4772			
—	23340	200	7.8740	7.8733	7.8720	7.8709			
—	23344	220	8.6614	8.6607	8.6594	8.6583			

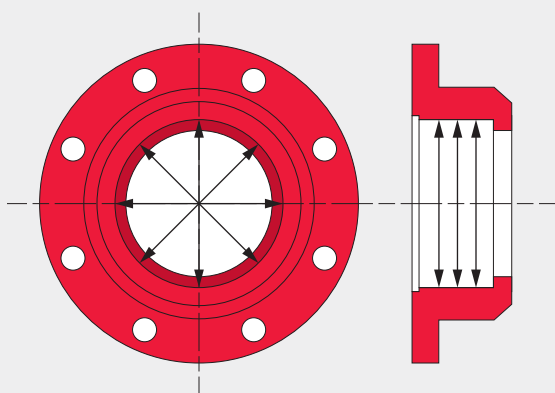

Checking Housings, Solid Type

BASIC BEARING NO.		BEARING OUTER DIAMETER DIMENSIONS					RECOMMENDED HOUSING FIT		
		mm	Tolerance μm		inch		inch		Resulting Fit
223	233	shaft	max	min	max	min	max	min	
22308	—	90	-5	-13	3.5431	3.5428	3.5427	3.5418	13 T / 1 T
22309	—	100			3.9368	3.9365	3.9364	3.9355	
22310	—	110			4.3305	4.3302	4.3301	4.3292	
22311	—	120			4.7242	4.7239	4.7238	4.7229	
22312	—	130			5.1179	5.1176	5.1173	5.1163	
22313	—	140	-5	-18	5.5116	5.5113	5.5110	5.5100	16 T / 3 T
22314	—	150			5.9053	5.9050	5.9047	5.9037	
22315	—	160			6.2990	6.2985	6.2978	6.2968	
22316	—	170			6.6927	6.6922	6.6915	6.6905	
22317	—	180			7.0864	7.0859	7.0852	7.0842	
22318	—	190	-10	-23	7.4800	7.4794	7.4787	7.4776	24 T / 7 T
22319	—	200			7.8737	7.8731	7.8724	7.8713	
22320	—	215			8.4642	8.4637	8.4630	8.4618	
22322	23322	240			9.4485	9.4479	9.4472	9.4461	
22324	23324	260			10.2358	10.2353	10.2344	10.2331	
22326	23326	280	-13	-28	11.0232	11.0227	11.0218	11.0205	27 T / 9 T
22328	23328	300			11.8106	11.8101	11.8092	11.8079	
22330	23330	320			12.5979	12.5973	12.5964	12.5950	
22332	23332	340			13.3853	13.3847	13.3838	13.3824	
22334	—	360			14.1727	14.1721	14.1712	14.1698	
22336	—	380	-13	-30	14.9601	14.9595	14.9586	14.9572	29 T / 9 T
22338	23338	400			15.7475	15.7469	15.7460	15.7446	
—	23340	420			16.5349	16.5343	16.5333	16.5317	
—	23344	460			18.1097	18.1091	18.1081	18.1065	

DESIGNATION SYSTEM - AFTERMARKET

SPHERICAL ROLLER BEARINGS FOR VIBRATING EQUIPMENT

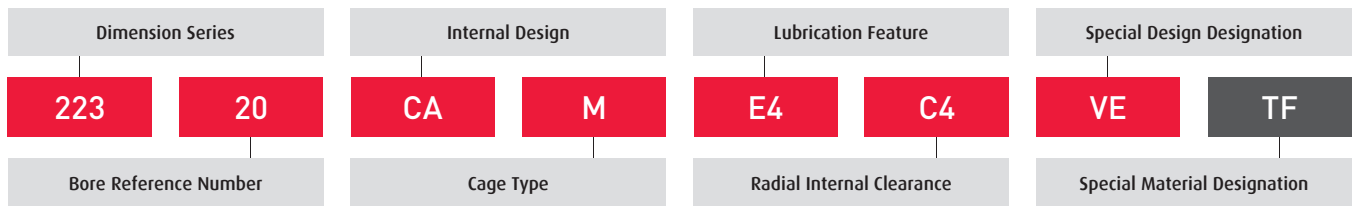

DESIGNATION	ATTRIBUTE	
Dimensional Series	223	heavy-duty type
	233	extra heavy-duty type, wide
Bore Reference Number		multiply x 5 for bearing bore diameter in millimeters
Internal Design	CA	high capacity design for optimized load ratings
Cage Type	M	machined brass cage
Lubrication Feature	E4	lubrication groove and holes in the outer ring

DESIGNATION	ATTRIBUTE	
Radial Internal Clearance	C4	standard to vibrating equipment
	C3	available upon request
Special Design Designation	VE	vibrating equipment specification with higher precision tolerances and special radial internal clearance range
Special Material Designation	TF	Tough Steel material option for longer operating life in contaminated environments



IMPROVEMENT PAYS

END-TO-END SERVICE DELIVERS CUSTOMER SUCCESS

Improvement never ends. And we never stop looking for better ways to support our customers in a complete, collaborative and continuous way. The focus of NSK isn't simply on a quick fix for immediate gain – it's about incremental and sustainable improvement to deliver long-term benefits.

When NSK is on-site, we're there to understand our customers' challenges and identify problems contributing to frequent bearing replacement, breakdowns caused by poor specification, high energy costs from inefficient product selection and lost production because of downtime. We collaborate with our customers to institute an **Asset Improvement Program (AIP)** that encompasses process and maintenance management, diagnostic and educational support to deliver measurable gains in output and cost-efficiency.

With NSK, our customers embark on a critical path to realizing improvements in equipment, productivity, people and financial performance.





NSK AMERICAS

United States
NSK Corporation
Ann Arbor MI
1.888.446.5675

Canada
NSK Canada Inc.
Brampton ON
1.888.603.7667

Mexico
NSK Rodamientos Mexicana,
S.A. de C.V.
Silao Guanajuato MX
52.472.500.9500

Brazil
NSK Brasil Ltda.
Suzano SP
55.11.4744.2500

Argentina
NSK Argentina SRL
Buenos Aires
54.11.4704.5100

Latin America
NSK Latin America Inc.
Miramar FL
1.305.477.0605

Website: www.nskamericas.com
NSK Global: www.nsk.com

Every care has been taken to ensure the accuracy of the data contained in this brochure, but no liability can be accepted for any loss or damage suffered through errors or omissions.

Printed in the USA ©NSK 2024.
The contents of the publication are the copyright of the publishers.